



Precision

Performance

Durability

2026

PRODUCTS CATALOG



OUR COMPANY

Tenaxis Welding Tables supplies precision-engineered welding tables for professional fabrication workshops worldwide.

Backed by Nexus Trade Group, Tenaxis combines global manufacturing, strategic distribution, and practical workshop knowledge to deliver modular table systems built for accuracy, durability, and long-term performance.

WHY CHOOSE US?

We make professional-grade welding fixture tables more accessible to workshops that need dependable equipment without inflated pricing. Every Tenaxis table is built for flatness, structural strength, and integration with a scalable fixturing system.

- Built for professional fabrication
- Precision CNC-machined surfaces
- Modular fixturing compatibility
- Transparent pricing
- Global distribution support
- Reliable performance for serious workshops

**SCAN THE QR CODE TO VISIT
OUR WEBSITE**

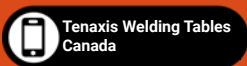

OUR BRANDS & PRODUCT LINES

NEXUS
— TRADE GROUP —

Nexus Trade Group is the parent company behind the brands below, delivering a portfolio of industrial solutions globally.

Ozcut
Abrasives

Built on over a decade of supplying welding tables and abrasives to the Australian market, Ozcut delivers practical, high-quality modular tables for everyday workshop use.

 **TENAXIS**
WELDING TABLES

Leveraging our experience in the Australian market, Tenaxis Welding Tables is our international brand, delivering high-quality welding tables to workshops worldwide.

 **THE FULL GRIP**

The Full Grip provides precision CNC workholding and fixturing solutions for machinists and manufacturers who value accuracy, repeatability, and efficiency, serving customers globally.

 **TAYLOR**
MACHINERY CO.

Taylor Machinery supplies the Australian market with CNC milling machines, lathes, air compressors, and other workshop machinery for industrial and fabrication businesses.

CONTENTS

Welding Table

TABLE SPECIFICATIONS	5
TABLE MATERIAL	6
Compare Our Table Series	7
Essentials Series Cast Iron Welding Table	11
Pro Series Nitrided Cast Iron Welding Table	12
Pro Series Nitrided Steel Welding Table	13
Pro Series Nitrided Steel 50x50mm Holes Welding Table	14
LEG OPTIONS	15
WELDING TABLE FIXTURES	16
FIXTURE KIT OPTIONS	17
BLOCKS	23
CAST IRON LOCATING SQUARES	24
EXTENSION & SMALL BLOCKS	25
LOCATING SQUARES	26
STOPS & FLAT SQUARES	27
SUPPORTS & DISCS	28
CLAMPS	29
TOGGLE CLAMPS	30
FAST CLAMPS	31
PINS	32
OTHER ACCESSORIES	33
REAL WORKSHOP SETUPS	34

TABLE SPECIFICATIONS

Discover precision-crafted welding tables designed to transform your welding experience. Our tables combine durability with meticulous design, featuring flat, machined surfaces and a grid of holes for secure and versatile work material positioning.

Upgrade your craftsmanship with tools that match your dedication to excellence.

Tolerances

- Flatness: $\pm 0.1\text{mm}$ (1m^2)
- Hole Distance: $\pm 0.05\text{mm}$
- Hole Diameter: $+0.05\text{mm}$

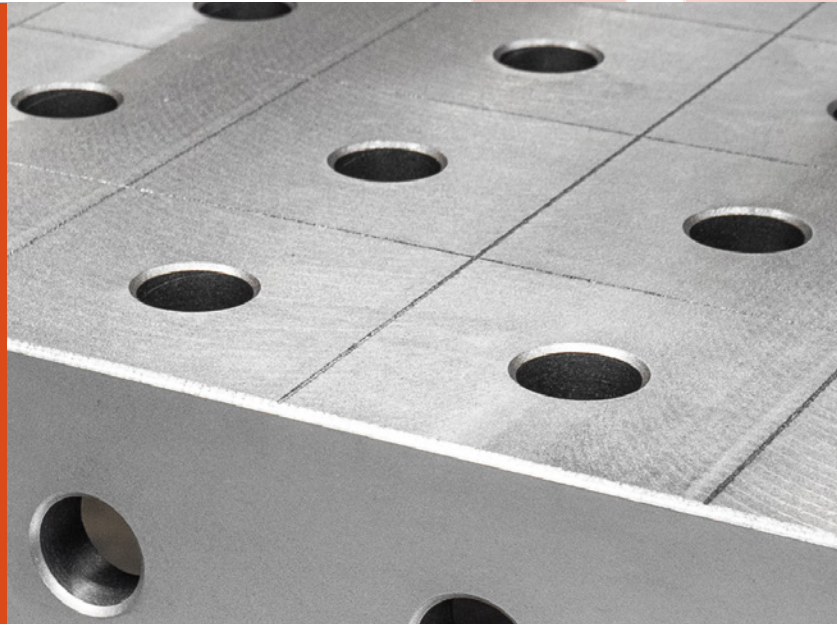

TABLE MATERIAL

Essentials Series

• CAST IRON

Cast in a single piece and precision-machined, these ~20 mm thick tables offer excellent flatness at the most economical price. Cast iron naturally resists welding spatter but has lower strength and toughness than steel, making it less ideal for heavy impacts or high-load use.



Pro Series

• NITRIDED CAST IRON

Cast in one piece and machined for precision, these ~25 mm thick tables are nitrided to further improve spatter resistance, hardness, and corrosion protection. The result is a durable, low-maintenance surface with long-term accuracy.



Pro Series



















• NITRIDED STEEL

Fabricated from S355 structural steel plate and fully machined after welding, these ~25 mm thick tables offer superior strength and impact resistance. Nitriding adds a hard, durable surface with excellent spatter and corrosion resistance — ideal for demanding fabrication work.



COMPARE OUR TABLE SERIES

*All of our tables are precision CNC-machined.

Specifications	Essentials Series	Pro Series Nitrided Cast Iron	Pro Series Nitrided Steel
Thickness	Approximately 20mm	Approximately 25mm	Approximately 25mm
Hole Size	28mm	28mm	28mm
Hole Pattern (Default)	 Standard Holes, 4 holes/100x100mm (Chamfered hole)	 Standard Holes, 4 holes/100x100mm (Chamfered hole)	 Standard Holes, 4 holes/100x100mm (Radiused hole)
Material	Raw Cast iron 	Nitrided Cast Iron 	Nitrided Steel 
Nitride Treatment			
Addon Options		<ul style="list-style-type: none">   Diagonal Holes;  Perimeter Ruler Engraving 	<ul style="list-style-type: none">   Diagonal Holes;   50x50mm Holes;  Perimeter Ruler Engraving

Hole Pattern Add-On (Available for Pro Series only)

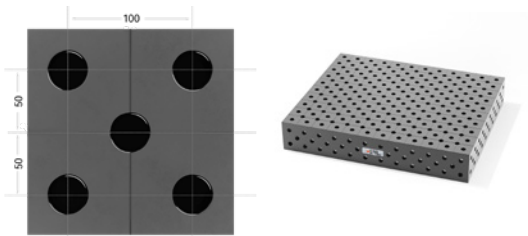

Diagonal Holes

Diagonal Holes (Optional Add-On)

The standard hole layout features a 100mm x 100mm grid. This optional upgrade adds a diagonal hole at the center of each square, offering greater flexibility for clamping and fixturing – enhancing the overall functionality of your welding table.

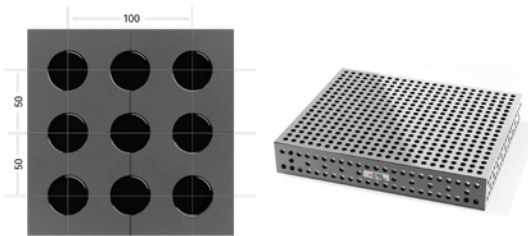

50x50mm Holes

50x50mm Holes (Nitrided Steel Table Optional Add-On)

The 50x50 mm hole pattern takes the diagonal layout a step further by adding four extra holes per 100x100 mm square, delivering unmatched precision and clamping flexibility for complex welding tasks.

Hole Pattern Comparison

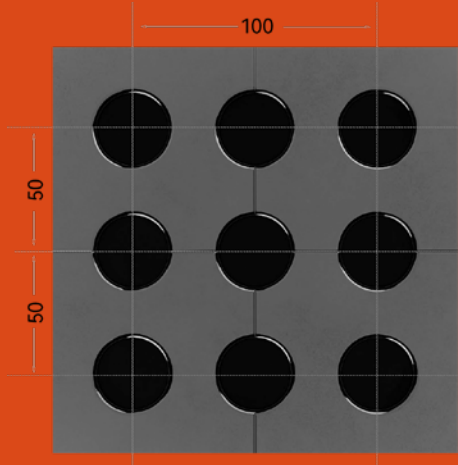

**50x50mm Holes
(9 holes/100x100mm)**

- Maximum flexibility and precision placement
- Extra heavy-duty ribbing underneath the table for added strength and rigidity.



**Diagonal Holes
(5 holes/100x100mm)**

- More options to place fixtures and clamps
- Added flexibility for varied setups

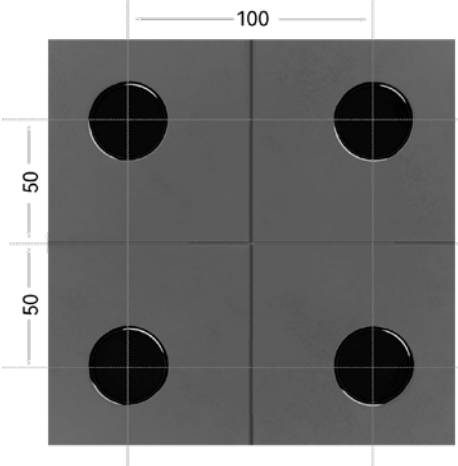
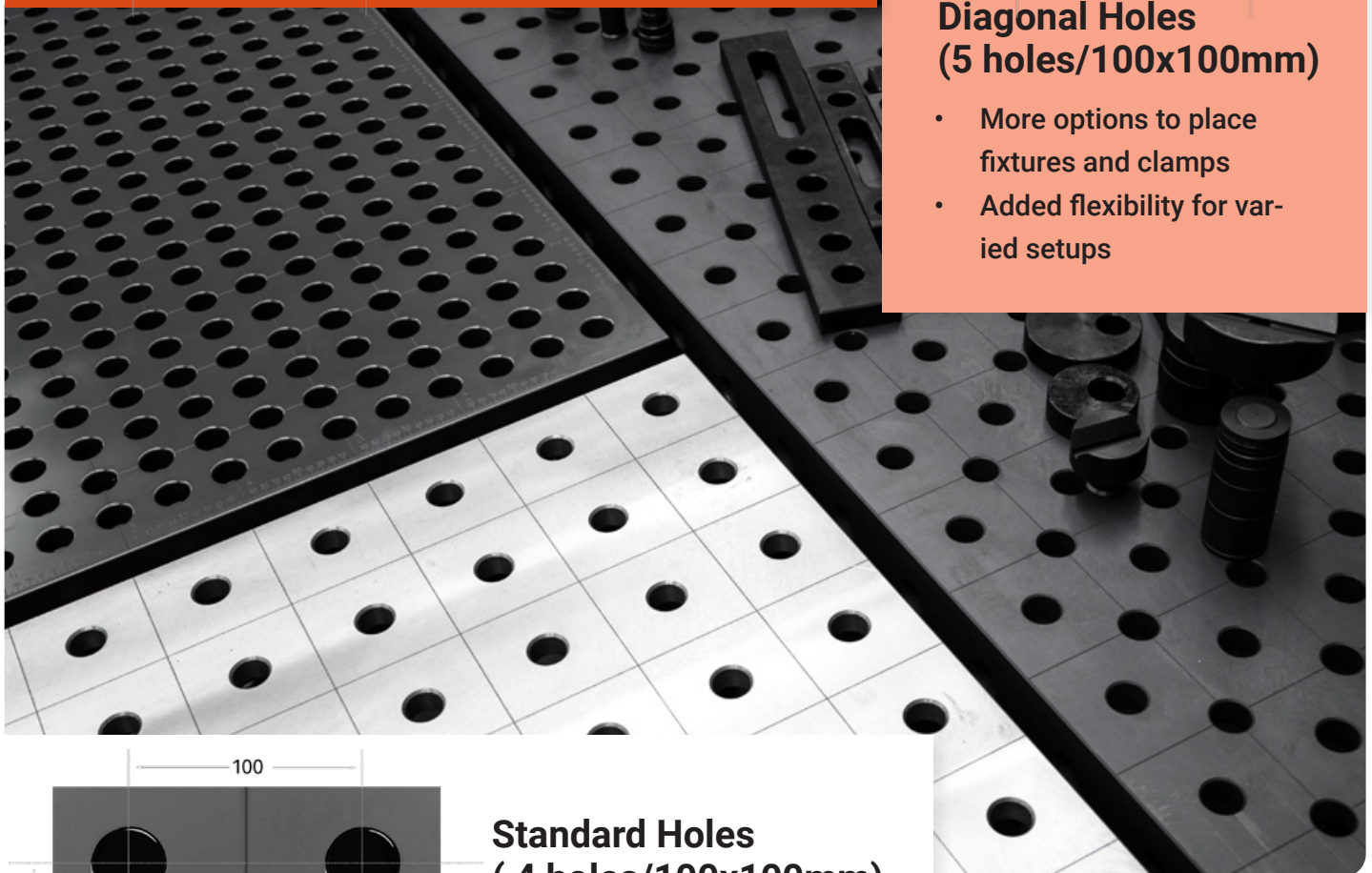

**Standard Holes
(4 holes/100x100mm)**

- Widely compatible with fixtures
- Great for most general welding

Perimeter Ruler Engraving Add-on

(Available for Pro Series only)

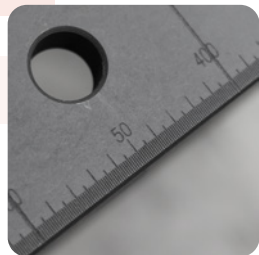

Nitrided Cast Iron Engraving



Nitrided Steel Engraving

Perimeter Ruler Engraving (Optional Add-On)

This optional feature adds a precision-engraved ruler along the edges of the table, providing instant reference for quick, accurate measurements — helping streamline your workflow and improve efficiency.



No Engraving

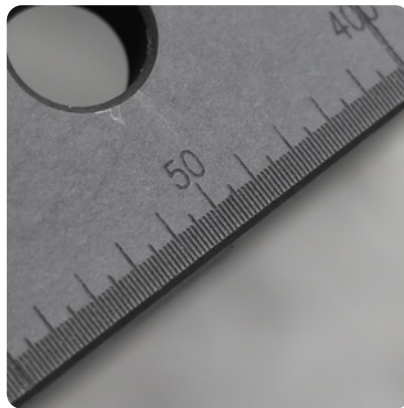

Add Engraving (Nitrided Cast Iron)



Add Engraving (Nitrided Steel)

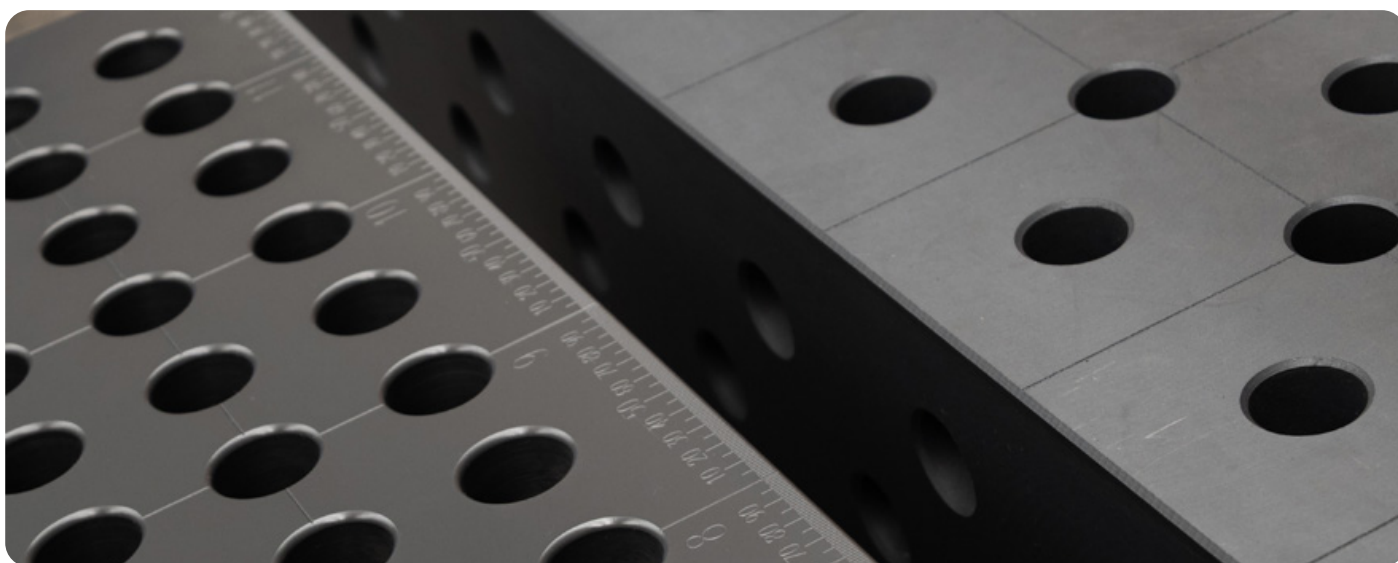

What is Nitride Treatment ?

Nitride Treatment is a surface hardening process that diffuses nitrogen into the steel, significantly increasing surface hardness while also improving wear, spatter, and corrosion resistance. This treatment extends the life of your welding table and maintains optimal performance in demanding environments.

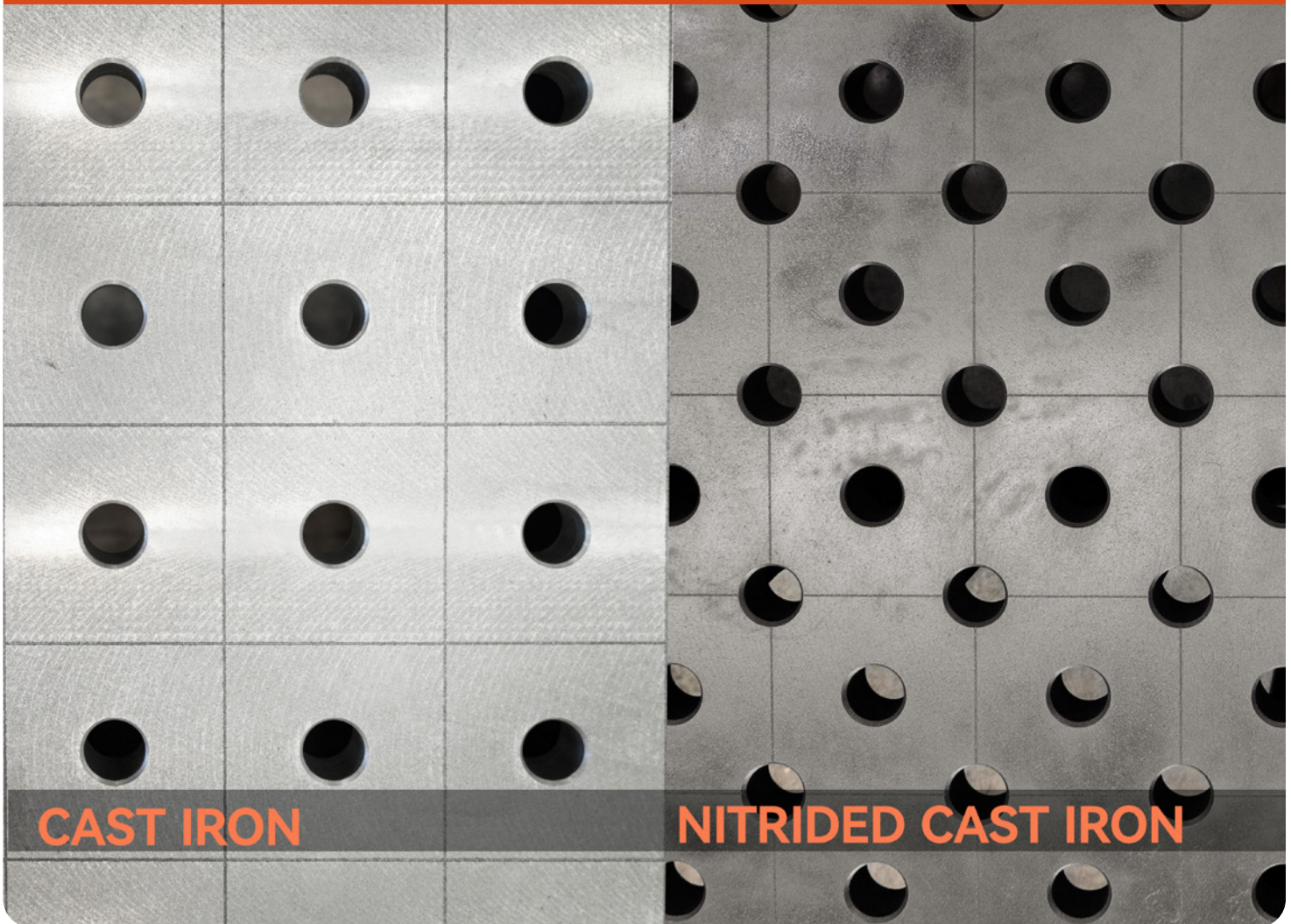

Essentials Series Cast Iron Welding Table

*We offer a range of stock sizes to suit most needs.
Custom sizes are also available upon request.



Size Options (mm/inches)	Weight(kg/lbs)	No. of Legs
1000x1000x200 (39.4"x39.4"x7.9")	250 / 551	4
1000x1200x200 (39.4"x47.2"x7.9")	350 / 772	4
1000x1500x200 (39.4"x59.1"x7.9")	420 / 926	4
1000x2000x200 (39.4"x78.7"x7.9")	500 / 1102	4
1000x3000x200 (39.4"x118.1"x7.9")	750 / 1653	6
1200x1200x200 (47.2"x47.2"x7.9")	400 / 882	4
1200x2400x200 (47.2"x94.5"x7.9")	750 / 1653	6
1500x1500x200 (59.1"x59.1"x7.9")	560 / 1235	4
1500x2000x200 (59.1"x78.7"x7.9")	760 / 1676	4
1500x2500x200 (59.1"x98.4"x7.9")	880 / 1940	6
1500x3000x200 (59.1"x118.1"x7.9")	1100 / 2425	6
2000x2000x200 (78.7"x78.7"x7.9")	1000 / 2205	5
2000x3000x200 (78.7"x118.1"x7.9")	1400 / 3086	8
2000x4000x200 (78.7"x157.5"x7.9")	1760 / 3880	10
1500x4000x200 (59.1"x157.5"x7.9")	1600 / 3527	8

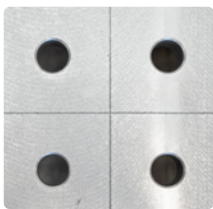

✓ Standard Holes

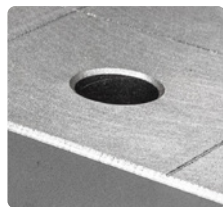

✓ Chamfered hole

Pro Series Nitrided Cast Iron Welding Table



*We offer a range of stock sizes to suit most needs.
Custom sizes are also available upon request.

Size Options (mm/inches)	Weight(kg/lbs)	No. of Legs
1000x1000x200 (39.4"x39.4"x7.9")	300 / 661	4
1000x1200x200 (39.4"x47.2"x7.9")	400 / 882	4
1000x1500x200 (39.4"x59.1"x7.9")	500 / 1102	4
1000x2000x200 (39.4"x78.7"x7.9")	600 / 1323	4
1000x3000x200 (39.4"x118.1"x7.9")	900 / 1984	6
1200x1200x200 (47.2"x47.2"x7.9")	480 / 1058	4
1200x2400x200 (47.2"x94.5"x7.9")	850 / 1874	6
1500x1500x200 (59.1"x59.1"x7.9")	700 / 1543	4
1500x2000x200 (59.1"x78.7"x7.9")	900 / 1984	4
1500x2500x200 (59.1"x98.4"x7.9")	1100 / 2425	6
1500x3000x200 (59.1"x118.1"x7.9")	1350 / 2976	8
2000x2000x200 (78.7"x78.7"x7.9")	1200 / 2646	5
2000x3000x200 (78.7"x118.1"x7.9")	1700 / 3748	8
2000x4000x200 (78.7"x157.5"x7.9")	2200 / 4850	10
1500x4000x200 (59.1"x157.5"x7.9")	2000 / 4409	8

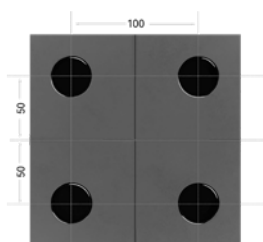

 **Standard Holes**

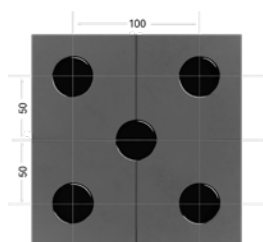

 **Diagonal Holes (Add-on)**



 **Perimeter Ruler Engraving (Add-on)**



 **Chamfered hole**

Pro Series Nitrided Steel Welding Table

*We offer a range of stock sizes to suit most needs.
Custom sizes are also available upon request.



Size Options (mm/inches)	Weight(kg/lbs)	No. of Legs
1000x1000x200 (39.4"x39.4"x7.9")	300 / 661	4
1000x1200x200 (39.4"x47.2"x7.9")	400 / 882	4
1000x1500x200 (39.4"x59.1"x7.9")	500 / 1102	4
1000x2000x200 (39.4"x78.7"x7.9")	600 / 1323	4
1000x3000x200 (39.4"x118.1"x7.9")	900 / 1984	6
1200x1200x200 (47.2"x47.2"x7.9")	480 / 1058	4
1200x2400x200 (47.2"x94.5"x7.9")	850 / 1874	6
1500x1500x200 (59.1"x59.1"x7.9")	700 / 1543	4
1500x2000x200 (59.1"x78.7"x7.9")	900 / 1984	4
1500x2500x200 (59.1"x98.4"x7.9")	1100 / 2425	6
1500x3000x200 (59.1"x118.1"x7.9")	1350 / 2976	8
2000x2000x200 (78.7"x78.7"x7.9")	1200 / 2646	5
2000x3000x200 (78.7"x118.1"x7.9")	1700 / 3748	8
2000x4000x200 (78.7"x157.5"x7.9")	2200 / 4850	10
1500x4000x200 (59.1"x157.5"x7.9")	2000 / 4409	8

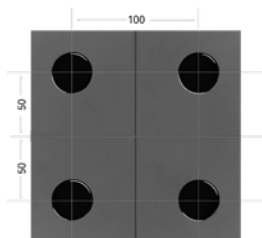

✓ Standard Holes

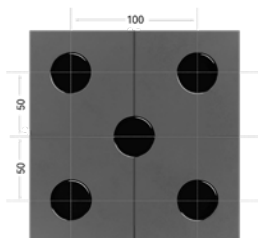

✓ Diagonal Holes (Add-on)

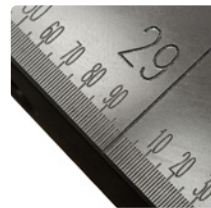

✓ Perimeter Ruler Engraving (Add-on)



✓ All steel table feature radiused holes

Pro Series Nitrided Steel 50x50mm Holes Welding Table

*We offer a range of stock sizes to suit most needs.

Custom sizes are also available upon request.

Size Options (mm/inches)	Weight(kg/lbs)	No. of Legs
1000x1000x200 (39.4"x39.4"x7.9")	300 / 661	4
1000x1200x200 (39.4"x47.2"x7.9")	400 / 882	4
1000x1500x200 (39.4"x59.1"x7.9")	500 / 1102	4
1000x2000x200 (39.4"x78.7"x7.9")	600 / 1323	4
1000x3000x200 (39.4"x118.1"x7.9")	900 / 1984	6
1200x1200x200 (47.2"x47.2"x7.9")	480 / 1058	4
1200x2400x200 (47.2"x94.5"x7.9")	850 / 1874	6
1500x1500x200 (59.1"x59.1"x7.9")	700 / 1543	4
1500x2000x200 (59.1"x78.7"x7.9")	900 / 1984	4
1500x2500x200 (59.1"x98.4"x7.9")	1100 / 2425	6
1500x3000x200 (59.1"x118.1"x7.9")	1350 / 2976	8
2000x2000x200 (78.7"x78.7"x7.9")	1200 / 2646	5
2000x3000x200 (78.7"x118.1"x7.9")	1700 / 3748	8
2000x4000x200 (78.7"x157.5"x7.9")	2200 / 4850	10
1500x4000x200 (59.1"x157.5"x7.9")	2000 / 4409	8

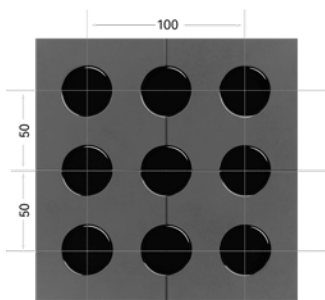

✓ 50x50mm Holes

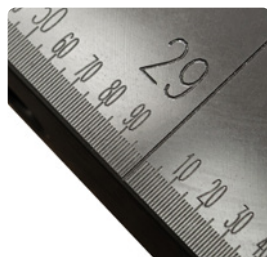

● Perimeter Ruler Engraving (Add-on)

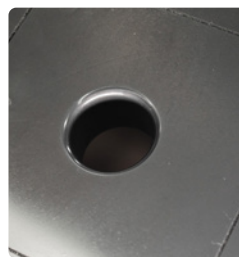







✓ All steel table feature radiused holes



✓ Reinforced base structure – added ribbing supports structural integrity

LEG OPTIONS

We offer a range of different leg options to match your table, or if you prefer to make your own, contact us.

Leg Options *Custom leg lengths available	Size
<p>Standard Round Fixed leg</p> <ul style="list-style-type: none"> • Solid metal foot for ultimate rigidity • 750kg/1653lbs load limit per 	 <p>Custom length available</p> <p>φ89mm (3.5") x 650mm (25.6") (850mm / 33.5" table top height)</p>
<p>Leg with Leveling Caster</p> <ul style="list-style-type: none"> • Roller caster for ease of movement • 500kg/1102lbs load limit 	 <p>Custom length available</p> <p>φ89mm (3.5") x 700mm (27.6") (900mm / 37.4" table top height)</p>
<p>Stainless Steel Adjustable Leg with Fixed Foot</p> <ul style="list-style-type: none"> • locally made in Melbourne from stainless steel square tube • 1400kg/3086lbs load limit 	 <ul style="list-style-type: none"> • 610 - 880mm (24" - 34.6") Finished table height • Adjustable in 50mm (2") increments
<p>Stainless Steel Adjustable Leg with Caster Wheel</p> <ul style="list-style-type: none"> • locally made in Melbourne from stainless steel square tube • 900kg/1984lbs load limit 	 <ul style="list-style-type: none"> • 690 - 950mm (27.2" - 37.4") Finished table height • Adjustable in 50mm (2") increments
<p>Stainless Steel Fixed Leg with Fixed Foot</p> <ul style="list-style-type: none"> • locally made in Melbourne from stainless steel square tube • 1400kg/3086lbs load limit 	 <p>600mm (23.6") (800mm / 31.5" table top height)</p> <p>700mm (27.6") (900mm / 35.4" table top height)</p> <p>Custom length available</p>
<p>Stainless Steel Fixed Leg with Caster Foot</p> <ul style="list-style-type: none"> • locally made in Melbourne from stainless steel square tube • 900kg/1984lbs load limit per leg 	 <p>600mm (23.6") (800mm / 31.5" table top height)</p> <p>650mm (25.6") (850mm / 33.5" table top height)</p> <p>700mm (27.6") (950mm / 37.4" table top height)</p> <p>800mm (31.5") (1000 / 39.4" table top height)</p>

WELDING TABLE FIXTURES

Fixtures are a critical part of any welding table system, designed to hold, position, and support workpieces with precision. They ensure accuracy, stability, and repeatability across every setup.

We offer a range of pre-configured toolkits that cover common fabrication needs, along with a full selection of individual fixtures for flexible setups. Custom solutions are also available to suit specific applications.

FIXTURE KIT OPTIONS

42-PIECE SMALL TOOLKIT

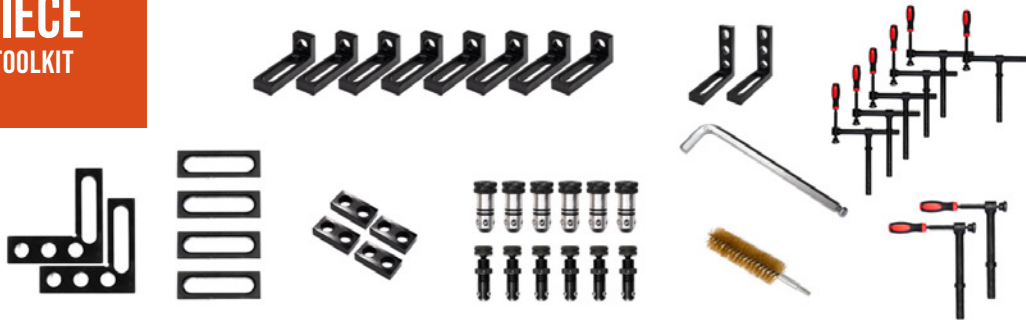

What's Included



8x T28-SQ-02
Locating Square-S



2x T28-SQ-05
Locating Square-M



4x T28-SF-01
Universal stop XS



4x T28-SF-02
Universal stop S



2x T28-SF-08
Flat Angle - S -
175x175x25mm



6x T28-C-180
180° Screw Clamp



2x T28-C-90
90° Screw Clamp



6x T28-P-02
Standard Ball Locking
Pin



6x T28-P-03
Adjustable Ball Locking
Pin with Shoulder



1x T28-A-05
Hex Key



1x T28-A-06
Brush

42-Piece Small Toolkit

75-PIECE LARGE TOOLKIT

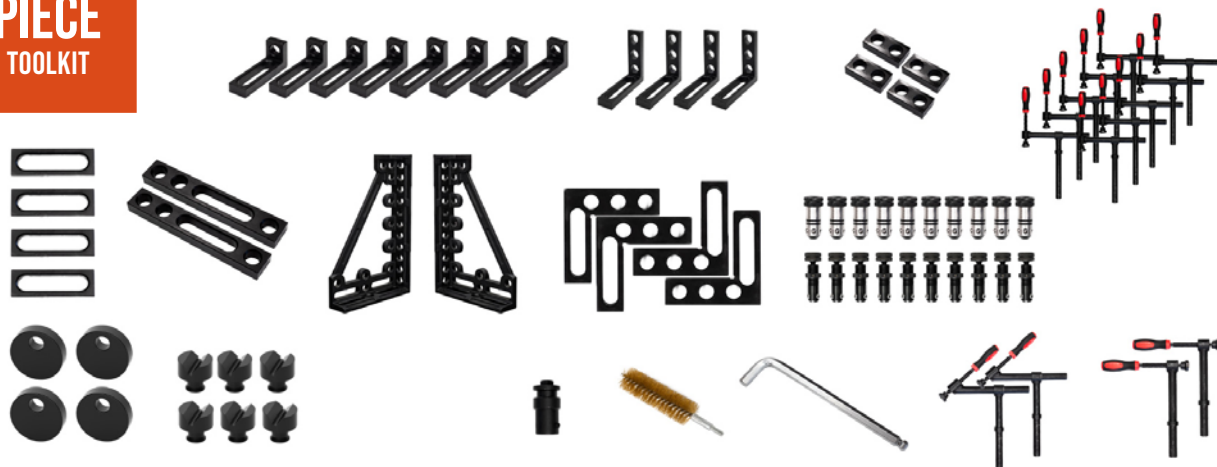

What's Included



1x T28-SQ-600-L
Clamping and locating
600 (Left)



1x T28-SQ-600-R
Clamping and locating
600 (Right)



8x T28-SQ-02
Locating Square-S



4x T28-SQ-05
Locating Square-M



4x T28-SF-01
Universal stop XS



4x T28-SF-02
Universal stop S



2x T28-SF-04
Universal stop - L
300x50x25mm



4x T28-SF-08
Flat Angle - S
-175x175x25mm



6x T28-SD-08
V-Cross Support -
φ58x90°



4x T28-SD-14
Locating Disc - 100



10x T28-C-180
180° Screw Clamp



2x T28-C-90
90° Screw Clamp



2x T28-C-45
45° Screw Clamp



10x T28-P-02
Standard Ball Locking
Pin



10x T28-P-03
Adjustable Ball Locking
Pin with Shoulder



1x T28-A-02
Earth Connector



1x T28-A-05
Hex Key



1x T28-A-06
Brush

75-Piece Large Toolkit

175-PIECE XL TOOLKIT

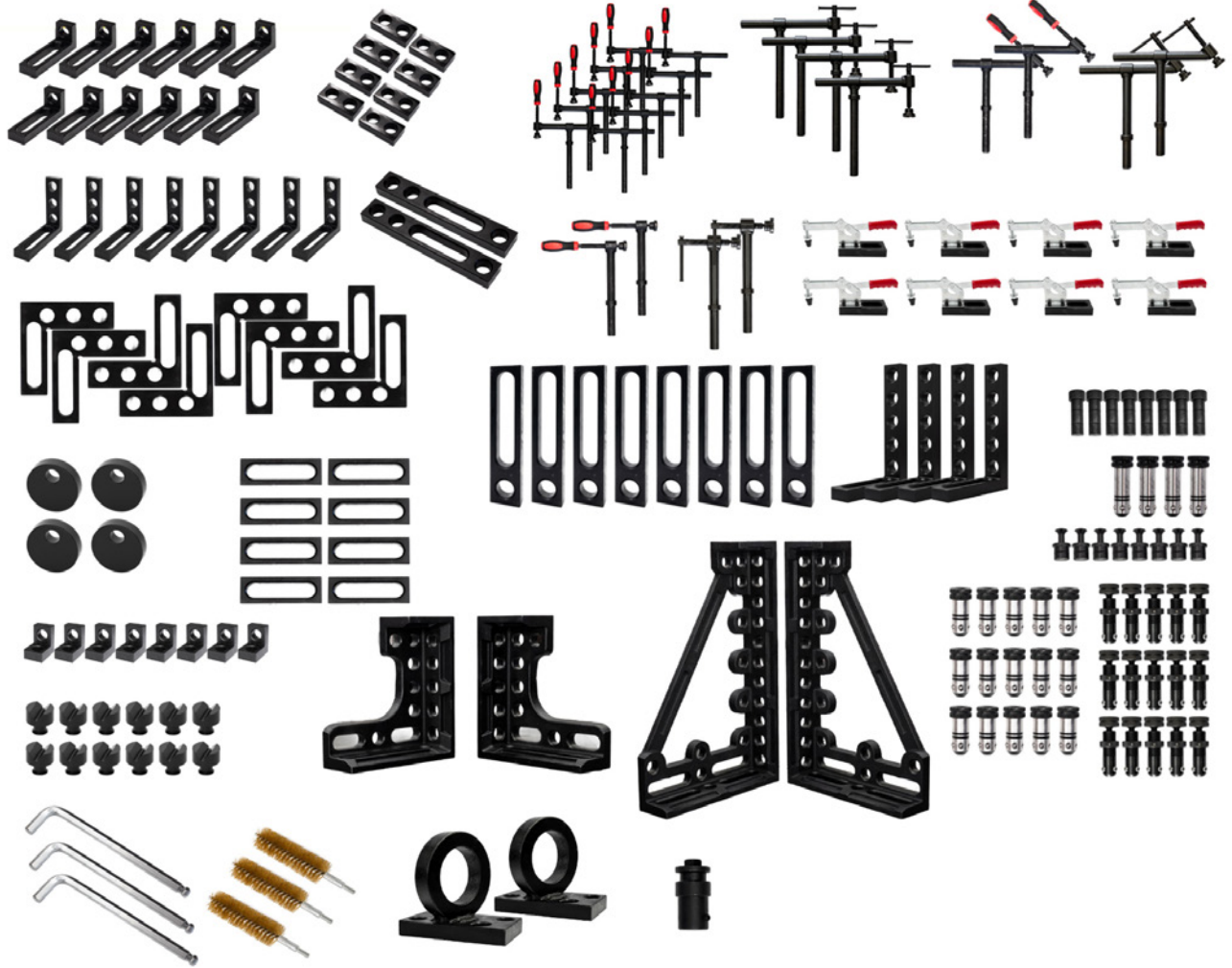

What's Included



1x T28-SQ-300-L
Clamping and locating
angle 300 (Left)



1x T28-SQ-300-R
Clamping and locating
angle 300 (Right)



1x T28-SQ-600-L
Clamping and locating
600 (Left)



1x T28-SQ-600-R
Clamping and locating
600 (Right)



8x T28-SQ-01
Locating Square-XS



12x T28-SQ-02
Locating Square-S



8x T28-SQ-05
Locating Square-M



4x T28-SQ-06
Locating Square-L



8x T28-SF-01
Universal stop XS -
100x50x25mm



8x T28-SF-02
Universal stop - S
150x50x25mm



8x T28-SF-03
Universal stop - M
225x50x25mm



2x T28-SF-04
Universal stop - L
300x50x25mm



8x T28-SF-08
Flat Angle - S
175x175x25mm



6x T28-SD-08
V-Cross Support -
φ58x90°



6x T28-SD-09
V-Cross Support -
φ58x120°



4x T28-SD-14
Locating Disc - 100



10x T28-C-180
180° Screw Clamp



4x T28-C-180-T
180° Screw Clamp
T handle



2x T28-C-90
90° Screw Clamp



2x T28-C-90-T
90° Screw Clamp
T Handle



2x T28-C-45
45° Screw Clamp



2x T28-C-45-T
45° Screw Clamp
T Handle



8x T28-TC-06
Horizontal Stop Toggle
Clamp TT-200-WL



8x T28-P-01
Location Pin



15x T28-P-02
Standard Ball Locking
Pin



15x T28-P-03
Adjustable Ball Locking
Pin with Shoulder



4x T28-P-05
Long Ball Locking Pin



8x T28-P-11
Magnetic Plug Pin -
25mm



2x T28-A-01
Table Lifting Lug



1x T28-A-02
Earth Connector



3x T28-A-05
Hex Key



3x T28-A-06
Brush

175-Piece XL Toolkit

280-PIECE XXL TOOLKIT

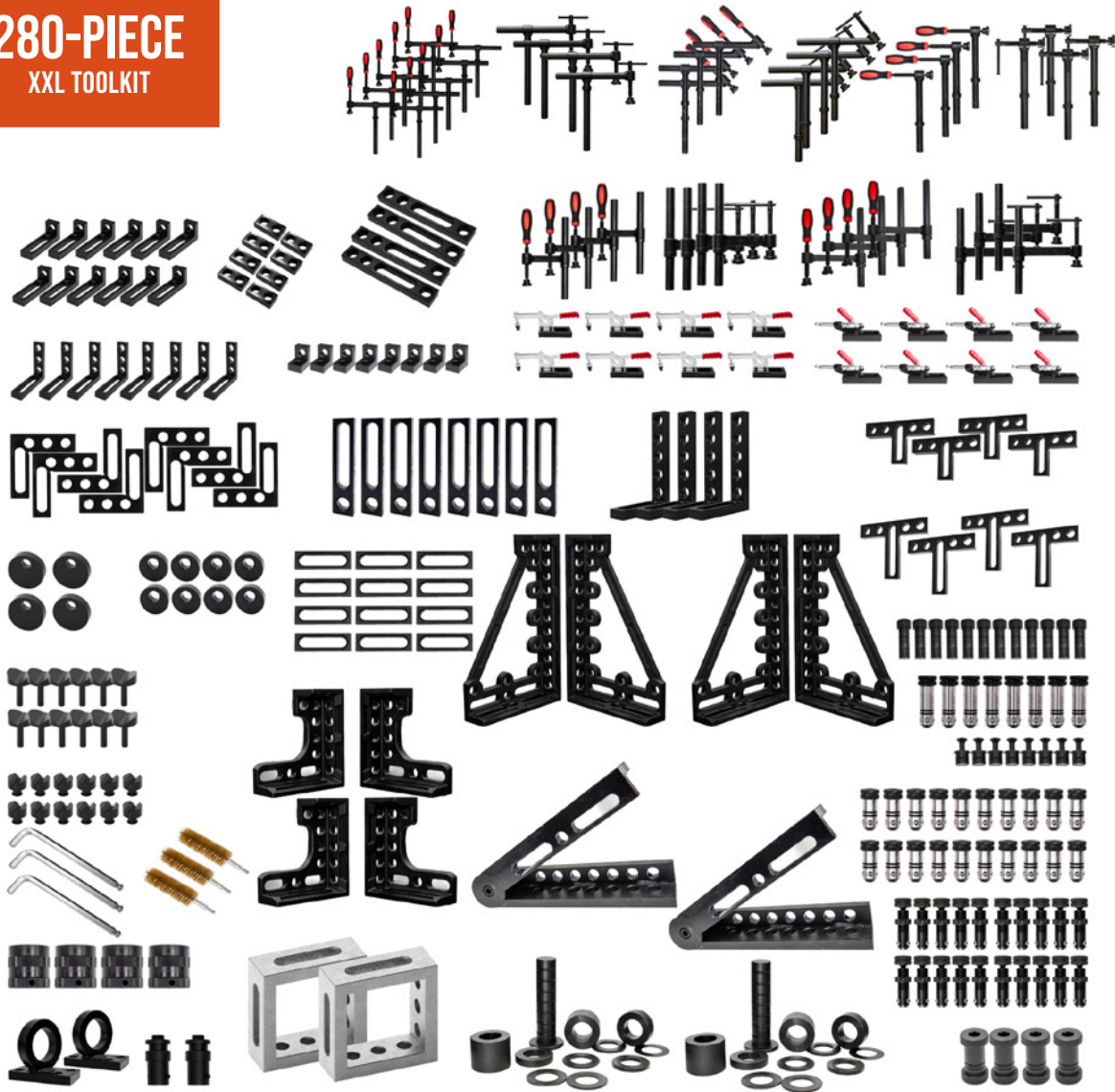

What's Included



2x T28-SQ-300-L
Clamping and locating
angle 300 (Left)



2x T28-SQ-300-R
Clamping and locating
angle 300 (Right)



2x T28-SQ-600-L
Clamping and locating
600 (Left)



2x T28-SQ-600-R
Clamping and locating
600 (Right)



2x T28-ES-02
Pivot & Set Angle
500x100x100mm



8x T28-SF-01
Universal stop XS



2x T28-ES-05
Frame Block
200x200x75mm



8x T28-SQ-01
Locating Square-XS



12x T28-SQ-02
Locating Square-S



8x T28-SQ-05
Locating Square-M



4x T28-SQ-06
Locating Square-L



12x T28-SF-02
Universal stop - S
150x50x25mm



8x T28-SF-03
Universal stop - M
225x50x25mm



4x T28-SF-04
Universal stop - L
300x50x25mm



8x T28-SF-08
Flat Angle - S
175x175x25mm



4x T28-SF-12
T Flat Angle
250x150x25mm



4x T28-SF-13
T Flat Angle
250x200x25mm



6x T28-SD-08
V-Cross Support -
 $\phi 58 \times 90^\circ$



6x T28-SD-09
V-Cross Support -
 $\phi 58 \times 120^\circ$



12x T28-SD-11
V-Adjust Support 120°



8x T28-SD-13
Locating Disc - 75



4x T28-SD-14
Locating Disc - 100



4x T28-SD-15
Height Adjustment
Device



10x T28-C-180
180° Screw Clamp



4x T28-C-180-T
180° Screw Clamp
T handle



4x T28-C-90
90° Screw Clamp



4x T28-C-90-T
90° Screw Clamp
T Handle



4x T28-C-45
45° Screw Clamp



4x T28-C-45-T
45° Screw Clamp
T Handle



4x T28-SC-150
Compensating Swing
Clamp 300x150mm



4x T28-SC-150-T
Compensating Swing
Clamp - T Handle -
300x150mm



4x T28-SC-200
Compensating Swing
Clamp 300x200mm



4x T28-SC-200-T
Compensating Swing
Clamp - T Handle -
300x200mm



8x T28-TC-05
90° Stop Toggle Clamp
TT-304-EM



8x T28-TC-06
Horizontal Stop Toggle
Clamp TT-200-WL



14x T28-P-01
Location Pin



20x T28-P-02
Standard Ball Locking
Pin



20x T28-P-03
Adjustable Ball Locking
Pin with Shoulder



8x T28-P-05
Long Ball Locking Pin



4x T28-P-10
Bolt-on Locking Pin



8x T28-P-11
Magnetic Plug Pin -
25mm



2x T28-A-01
Table Lifting Lug



2x T28-A-02
Earth Connector



3x T28-A-05
Hex Key



3x T28-A-06
Brush



2x T28-SD-16
Spacer Set - 28mm
Welding Tables







280-Piece XXL Toolkit

BLOCKS

Available in cast iron, nitrided cast iron, and nitrided steel

Name	Photo	SKU	Dimension(mm)
U-Shape Square Box		T28-UB-01	500x200x200
U-Shape Square Box		T28-UB-02	1000x200x200
U-Shape Square Box		T28-UB-03	1200x200x200
U-Shape Square Box		T28-UB-04	1500x200x200
U-Shape Square Box		T28-UB-05	2000x200x200
U-Shape Square Box		T28-UB-06	2400x200x200
U-Shape Square Box		T28-UB-07	3000x200x200
U-Shape Square Box		T28-UB-08	4000x200x200
U-Shape Square Box		T28-UB-09	1200x400x200
U-Shape Square Box		T28-UB-10	2400x400x200
L-Shape Square Box		T28-LB-01	500x200x100
L-Shape Square Box		T28-LB-02	1000x200x100
L-Shape Square Box		T28-LB-03	1200x200x100
L-Shape Square Box		T28-LB-04	1500x200x100









CAST IRON LOCATING SQUARES

Name	Photo	SKU	Dimension(mm)
Clamping and locating angle 300 (Left)		T28-SQ-300-L	300x275x95 (L)
Clamping and locating angle 300 (Right)		T28-SQ-300-R	300x275x95 (R)
Clamping and locating angle 600 (Left)		T28-SQ-600-L	600x375x95 (L)
Clamping and locating angle 600 (Right)		T28-SQ-600-R	600x375x95 (R)
Clamping and locating angle 800 (Left)		T28-SQ-800-L	800x375x95 (L)
Clamping and locating angle 800 (right)		T28-SQ-800-R	800x375x95 (R)













EXTENSION & SMALL BLOCKS

Product Name	Photo	SKU	Dimension(mm)
Table Corner Extension		T28-ES-01	200x200x175
Pivot & Set Angle		T28-ES-02	500x100x100
30° Angled Block		T28-ES-03	150x150x75x30°
45° Angled Block		T28-ES-04	150x150x75x45°
Frame Block		T28-ES-05	200x200x75
Frame Block		T28-ES-06	200x150x75
Frame Block		T28-ES-07	200x100x75
Frame Block		T28-ES-08	200x200x100
Frame Block		T28-ES-09	200x150x100
Frame Block		T28-ES-10	200x100x100

LOCATING SQUARES

Product Name	Photo	SKU	Dimension(mm)
Locating Square - XS		T28-SQ-01	75x50x75
Locating Square - S		T28-SQ-02	175x50x75
Locating Square - M		T28-SQ-03	175x50x175 (holes/holes)
Locating Square - M		T28-SQ-04	175x50x175 (slot/slot)
Locating Square - M		T28-SQ-05	175x50x175 (holes/slot)
Locating Square - L		T28-SQ-06	275x50x175
Locating Square - XL		T28-SQ-07	300*200*75
Locating Square - 2XL		T28-SQ-08	500*200*75













STOPS & FLAT SQUARES

Product Name	Photo	SKU	Dimension(mm)
Universal stop XS		T28-SF-01	100x50x25
Universal stop S		T28-SF-02	150x50x25
Universal stop M		T28-SF-03	225x50x25
Universal stop L		T28-SF-04	300x50x25
Universal stop XL		T28-SF-05	500x75x25
Universal stop 2XL		T28-SF-06	800x75x25
Universal stop 3XL		T28-SF-07	1000x100x25
Flat Angle - S		T28-SF-08	175x175x25
Flat Angle - M		T28-SF-09	275x225x25
Flat Angle - L		T28-SF-10	325x225x25
Flat Angle - XL		T28-SF-11	500x375x25
T Flat Angle		T28-SF-12	250x150x25
T Flat Angle		T28-SF-13	250x200x25





SUPPORTS & DISCS

Product Name	Photo	SKU	Dimension(mm)
120° V-Flat Support		T28-SD-01	150x75x25x120°
V-Square Support		T28-SD-02	250x100x75x120°
90° V-Square Support		T28-SD-03	175x103x75x90°
90° V-Square Support		T28-SD-04	175x103x75x90°
V-Square Support		T28-SD-05	250x150x75x120°
V-Square Support		T28-SD-06	250x100x75x120°
90° V-Square Support		T28-SD-07	175x103x75x90°
V-Cross Supportφ58x90°		T28-SD-08	φ58x50(H)-90°
V-Cross Supportφ58x120°		T28-SD-09	φ58x50(H)-120°
V-Cross Supportφ58x140°		T28-SD-10	φ58x50(H)-140°
V-Adjust Support 120°		T28-SD-11	φ110x120(H)-120°
V-Adjust Support 140°		T28-SD-12	φ140x120(H)-140
Locating Disc - 75		T28-SD-13	50xφ75x25
Locating Disc - 100		T28-SD-14	75xφ100x25
Height Adjustment Device		T28-SD-15	φ80-75x100
Spacer Set (11-Pieces)		T28-SD-16	Ø28 Hole, 125 mm Overall Height

CLAMPS



Product Name	Photo	SKU	Dimension(mm)
180° Screw Clamp		T28-C-180	300x300
180° Screw Clamp T Handle		T28-C-180-T	300x300
90° Screw Clamp		T28-C-90	300x150
90° Screw Clamp T Handle		T28-C-90-T	300x150
45° Screw Clamp		T28-C-45	300x300
45° Screw Clamp T Handle		T28-C-45-T	300x300
Compensating Swing Clamp		T28-SC-150	300x150
Compensating Swing Clamp T Handle		T28-SC-150-T	300x150
Compensating Swing Clamp		T28-SC-200	300x200
Compensating Swing Clamp T Handle		T28-SC-200-T	300x200
Two Point Bridge Clamp		T28-BC-2	170x35x20
Three Point Bridge Clamp		T28-BC-3	170x35x20

TOGGLE CLAMPS

Product Name	Photo	SKU	Arm Length	Clamping Height (approx.)
180° Pin Toggle Clamp – Vertical Handle		T28-TC-01	110mm	0-18mm
Horizontal Toggle Clamp		T28-TC-03	100mm	10-33mm
180° Stop Toggle Clamp		T28-TC-04	100mm	15-33mm
Horizontal Stop Toggle Clamp		T28-TC-06	110mm	25-50mm

Product Name	Photo	SKU	Stroke Length	Off-Surface Height
90° Pin Toggle Clamp		T28-TC-02	42mm	42mm
90° Stop Toggle Clamp		T28-TC-05	42mm	57mm





FAST CLAMPS

Product Name	Photo	SKU	Max Clamping Range (mm)	Arm Length (mm)
Fast Clamp		T28-FC-160-60	160	60
Fast Clamp		T28-FC-200-120	200	120
Fast Clamp		T28-FC-300-120	300	120

PINS

Product Name	Photo	SKU	Dimension(mm)
Location Pin		T28-P-01	φ40xφ28x80
Standard Ball Locking Pin		T28-P-02	φ28X50
Pro series Ball Locking Pin		T28-P-04	φ28X50
Adjustable Ball Locking Pin with Shoulder		T28-P-03	φ28X50
Long Ball Locking Pin		T28-P-05	φ28x75
C/S Ball Locking Pin		T28-P-06	φ28X50
Handle Ball Locking Pin		T28-P-07	φ28X50
Bolt-on Double C/S Lock Pin - 50		T28-P-08	φ28x50
Bolt-on Double C/S Lock Pin - 75		T28-P-09	φ28x75
Bolt-on Locking Pin - 50		T28-P-10	φ28x50
Magnetic Plug Pin - 25		T28-P-11	φ28x25
Magnetic Plug Pin - 50		T28-P-12	φ28x50

OTHER ACCESSORIES

Product Name	Photo	Product Code	Dimension(mm)
Earth Connector		T28-A-02	φ28
Hex Key		T28-A-05	14mm
Brush		T28-A-06	φ30x80
Tool Cart		T28-A-07	1000*600*1065

REAL WORKSHOP **SETUPS**

